



US 20090177569A1

(19) **United States**

(12) **Patent Application Publication**
Bowers et al.

(10) **Pub. No.: US 2009/0177569 A1**
(43) **Pub. Date: Jul. 9, 2009**

(54) **WATER ALTERATION STRUCTURE RISK
MANAGEMENT OR ECOLOGICAL
ALTERATION MANAGEMENT SYSTEMS
AND METHODS**

(21) Appl. No.: **12/006,804**
(22) Filed: **Jan. 3, 2008**

Related U.S. Application Data

(76) Inventors: **Jeffrey A. Bowers**, Kirkland, WA (US); **Kenneth G. Caldeira**, Campbell, CA (US); **Alistair K. Chan**, Stillwater, MN (US); **William H. Gates, III**, Redmond, WA (US); **Roderick A. Hyde**, Redmond, WA (US); **Muriel Y. Ishikawa**, Livermore, CA (US); **Jordin T. Kare**, Seattle, WA (US); **John Latham**, Boulder, CO (US); **Nathan P. Myhrvold**, Medina, WA (US); **Stephen H. Salter**, Edinburgh (GB); **Clarence T. Tegreene**, Bellevue, WA (US); **Lowell L. Wood, JR.**, Bellevue, WA (US)

(63) Continuation-in-part of application No. 12/006,815, filed on Jan. 3, 2008, Continuation-in-part of application No. 12/006,805, filed on Jan. 3, 2008, Continuation-in-part of application No. 12/006,823, filed on Jan. 3, 2008.

Publication Classification

(51) **Int. Cl.**
G06Q 99/00 (2006.01)
(52) **U.S. Cl.** **705/35; 705/1**

(57) **ABSTRACT**

A method of managing risk includes selling individual insurance policies regarding areas to be protected by storm suppression equipment. The method discussed also includes finding at least one of purchase, operation, or maintenance of the storm suppression equipment at least partially through premiums collected from the selling.

Correspondence Address:
Searete LLC
Suite 110, 1756 - 114th Ave. S.E.
Bellevue, WA 98004 (US)

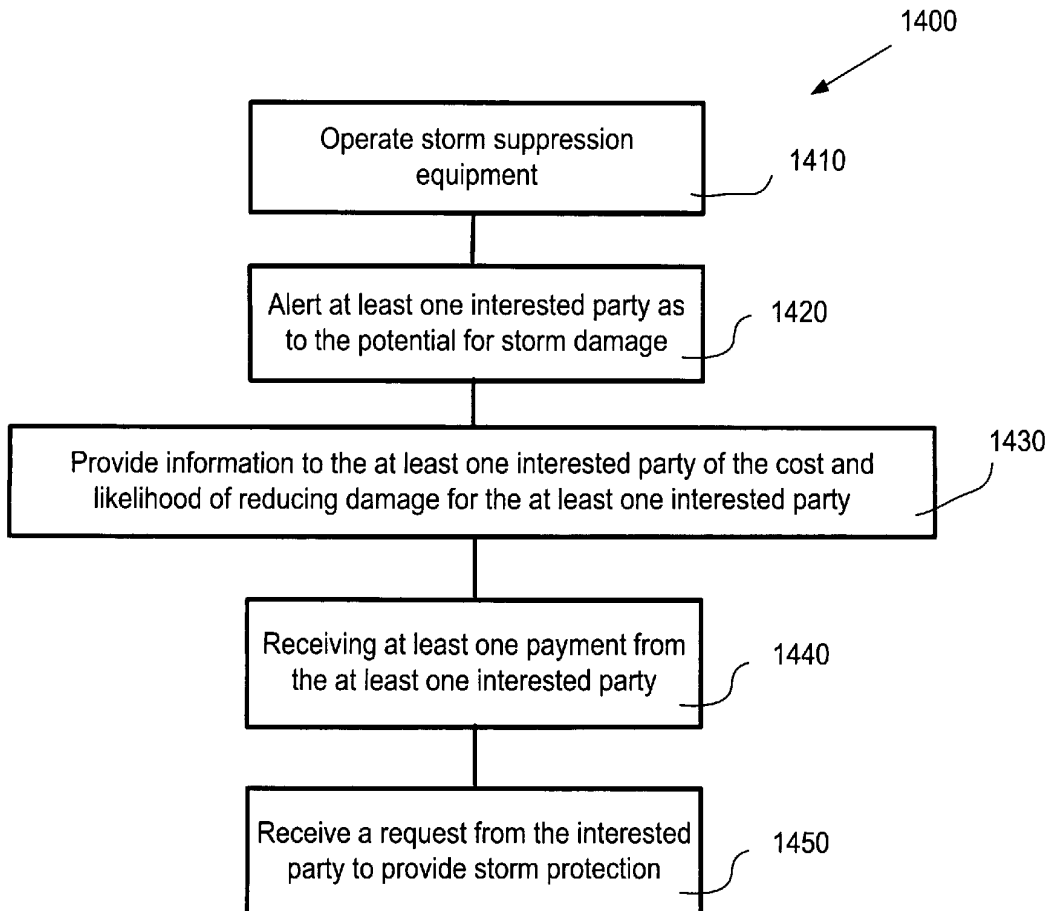

FIG. 2

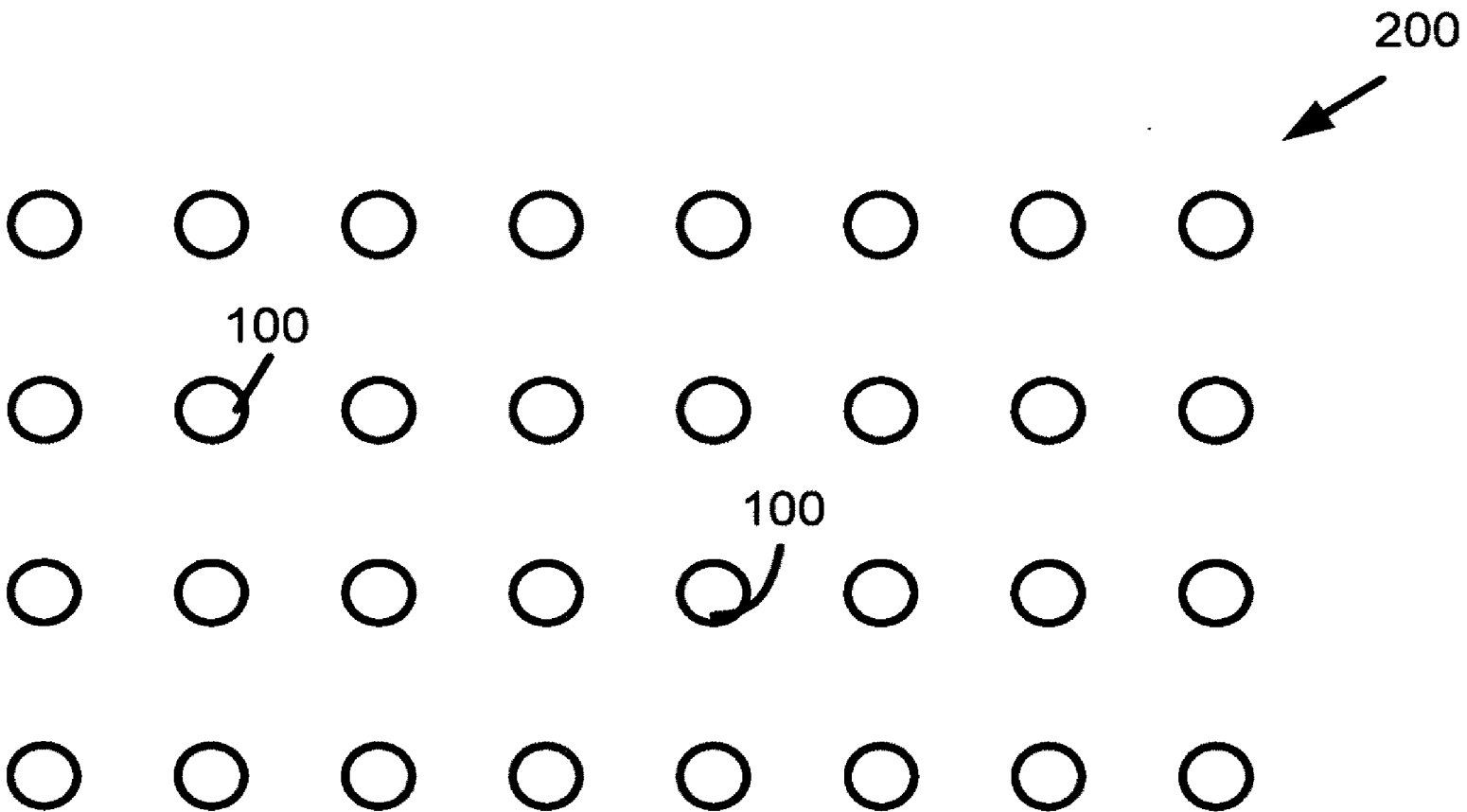

FIG. 3

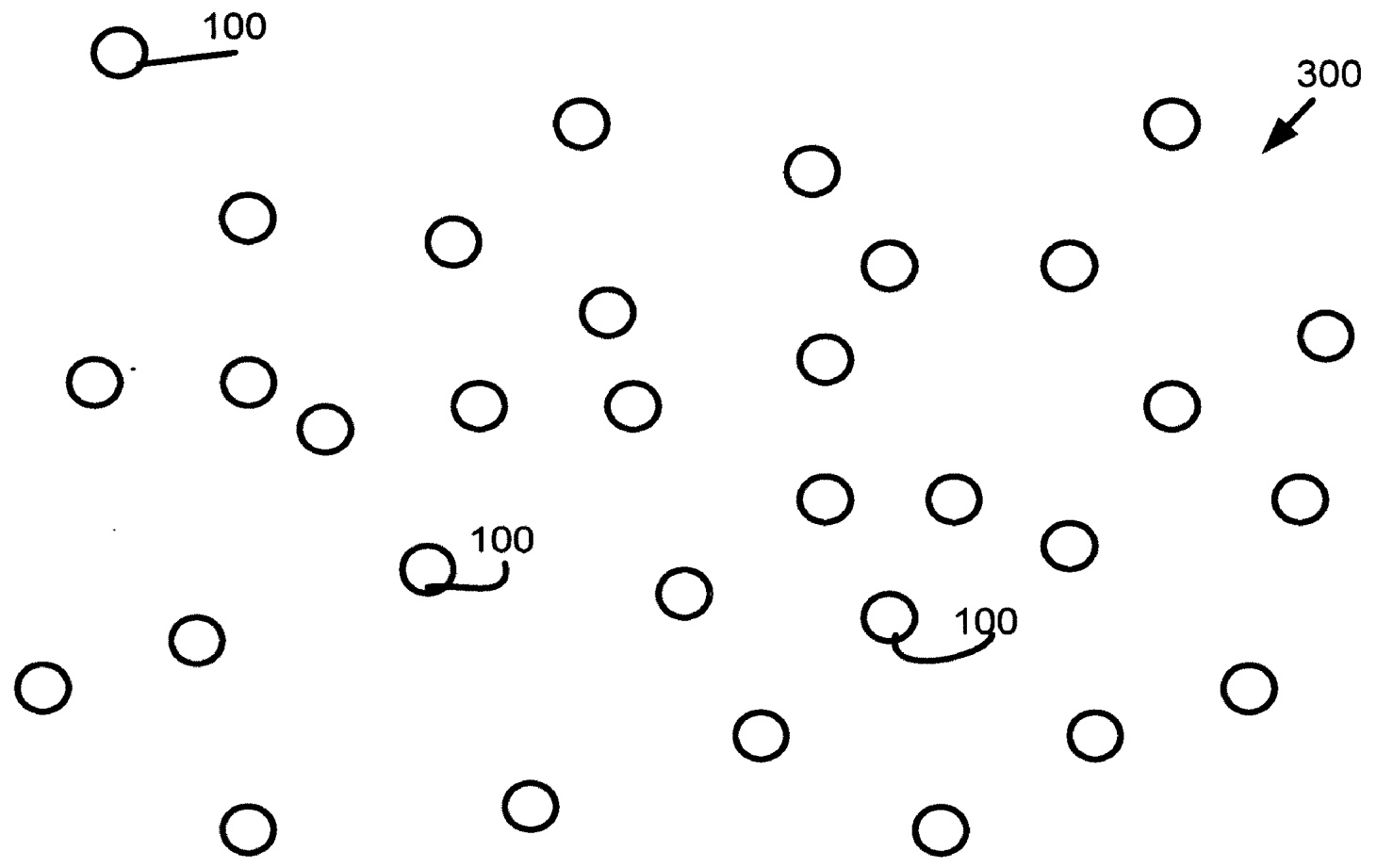

FIG. 4

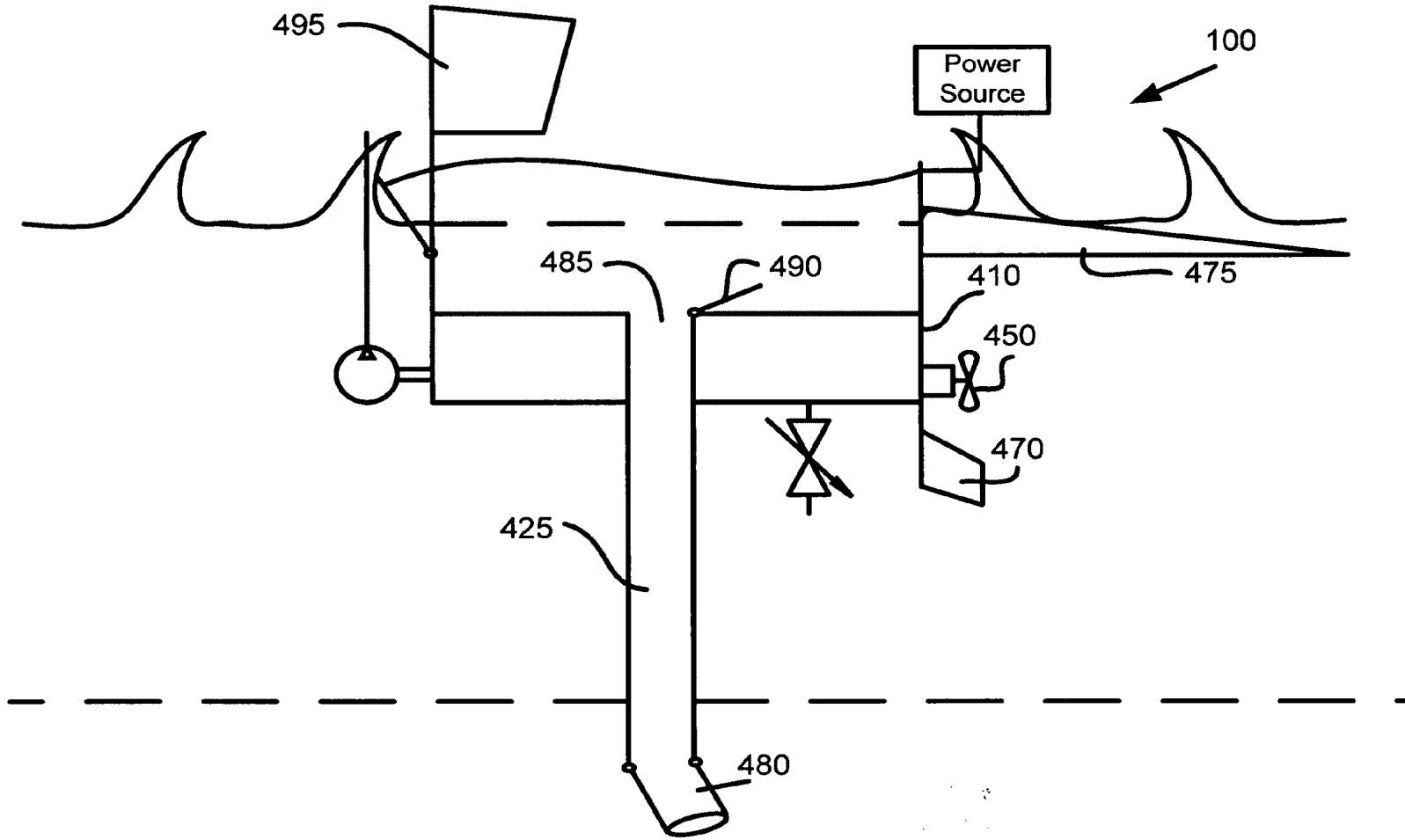

FIG. 5

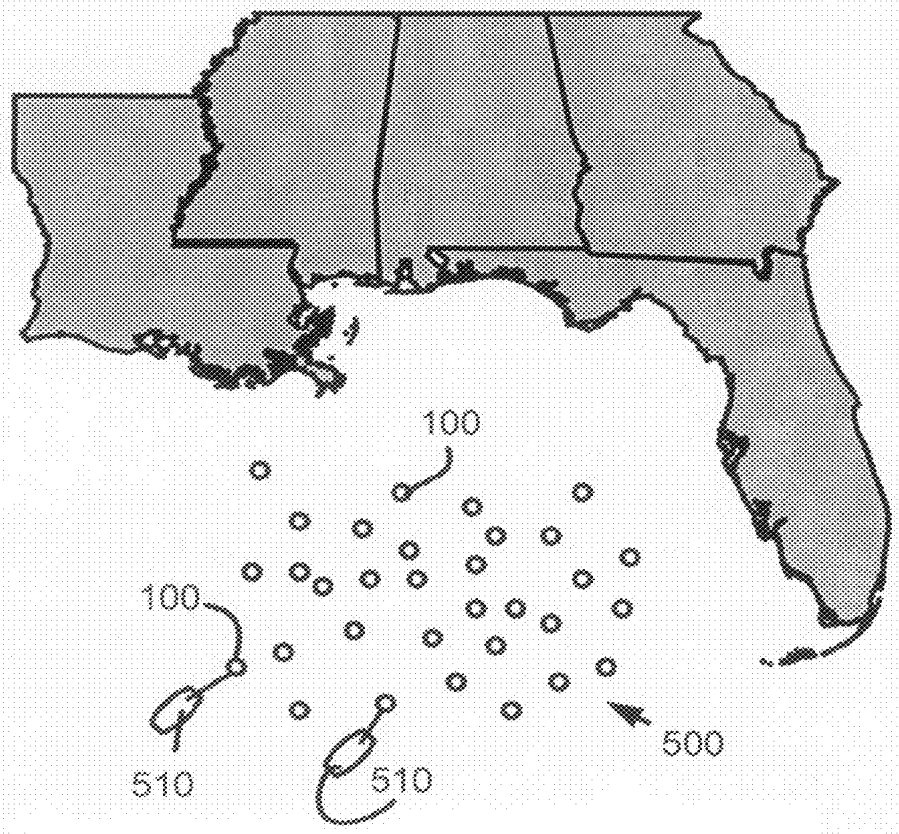

FIG. 6

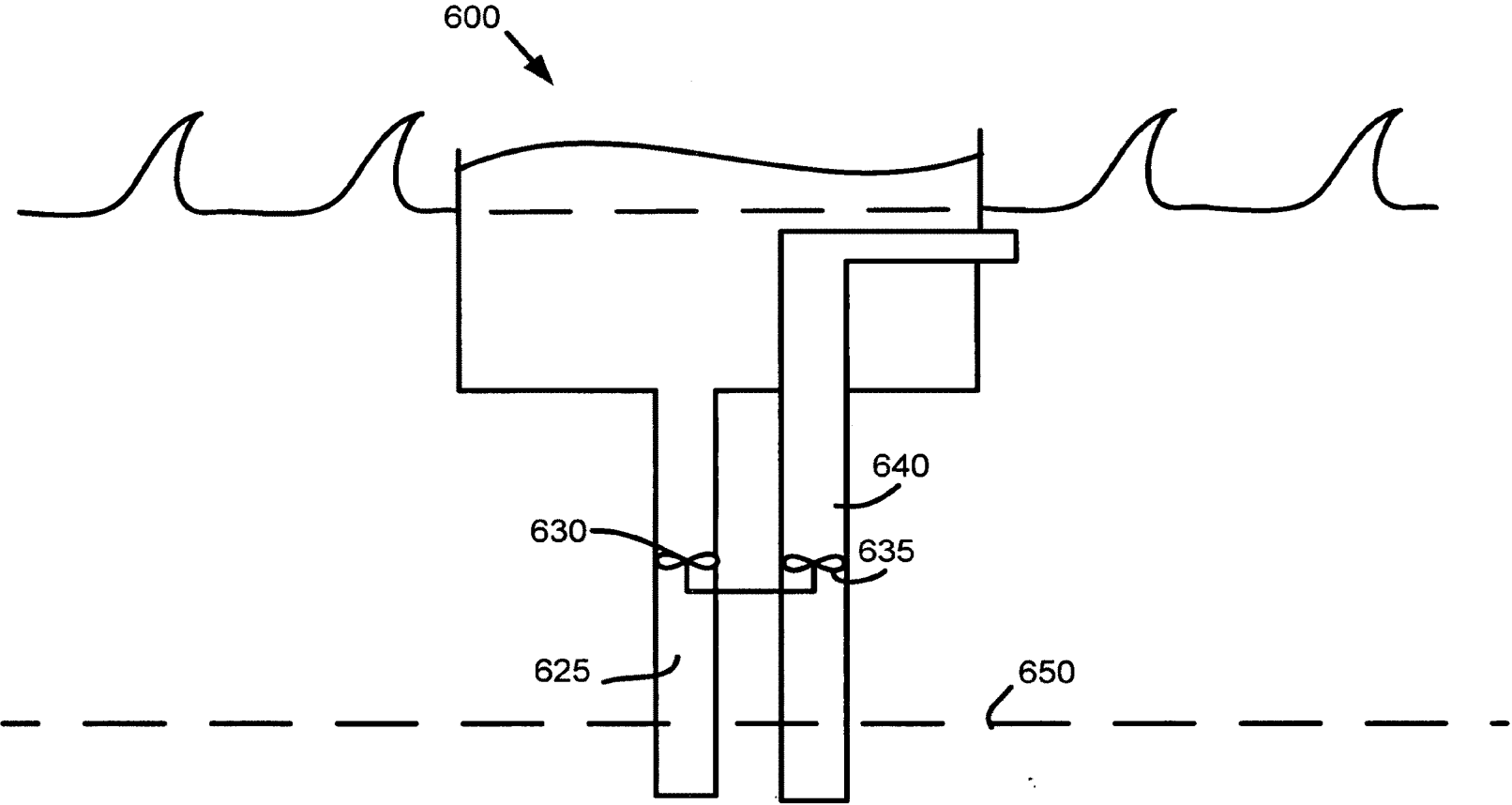

FIG. 7

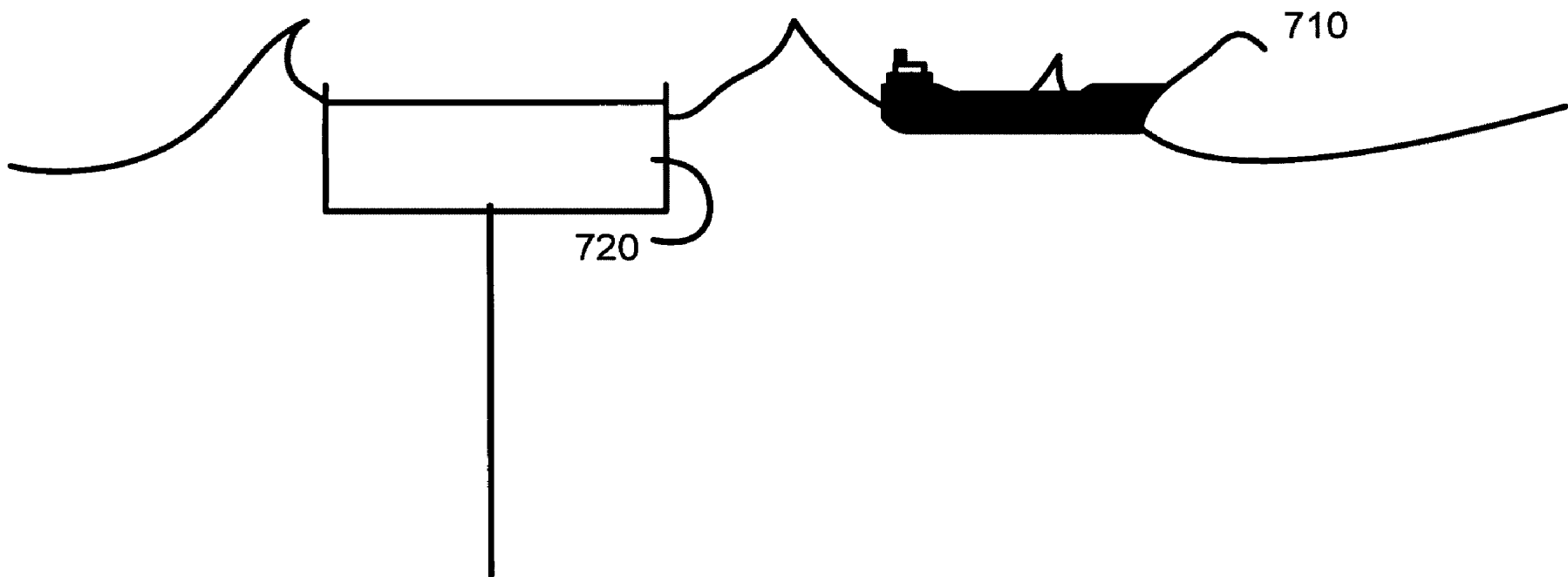

FIG. 8

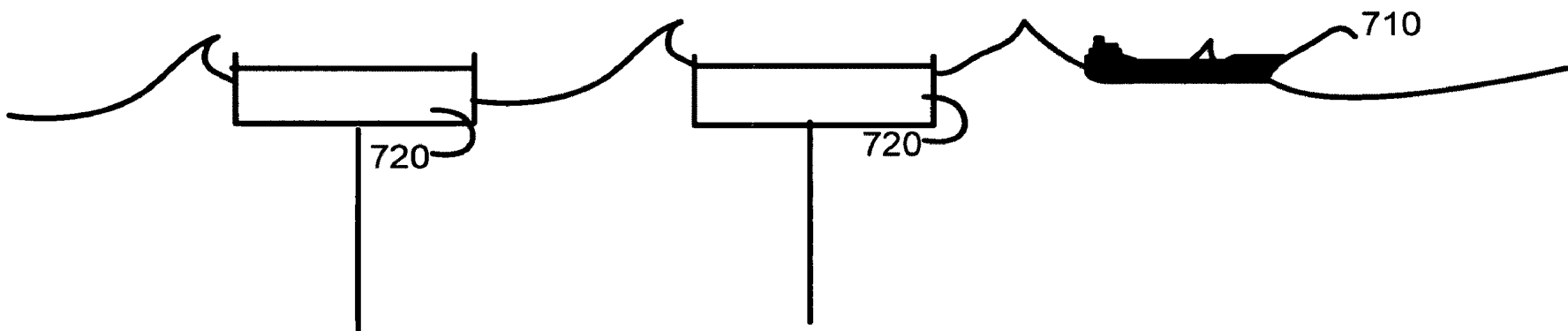

FIG. 9

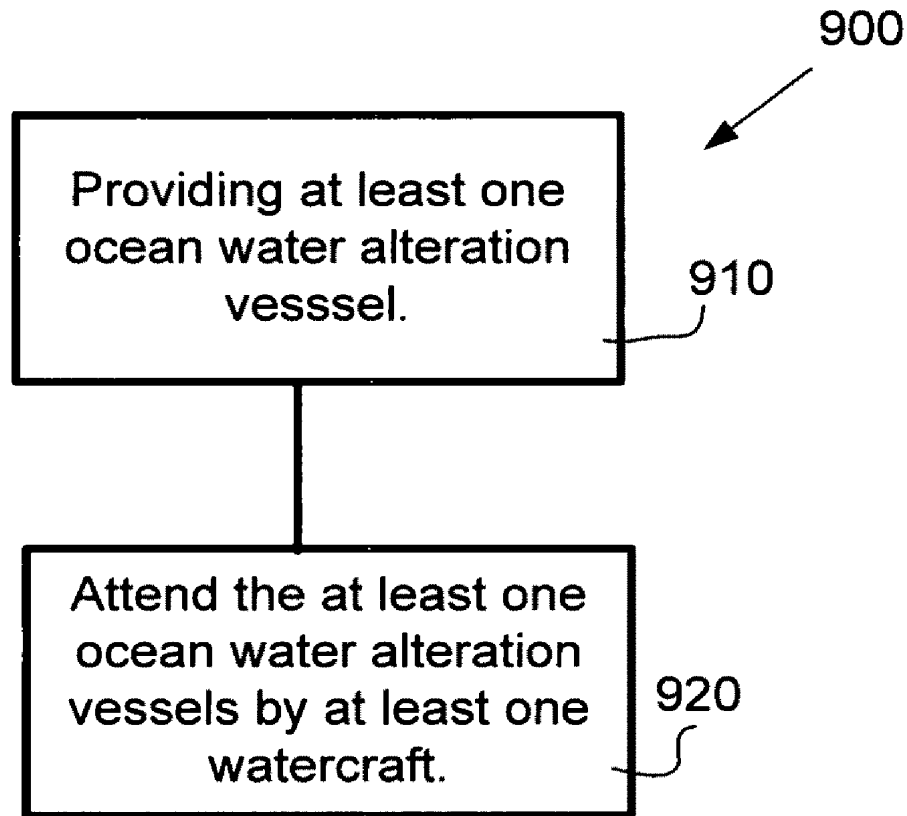

FIG. 10

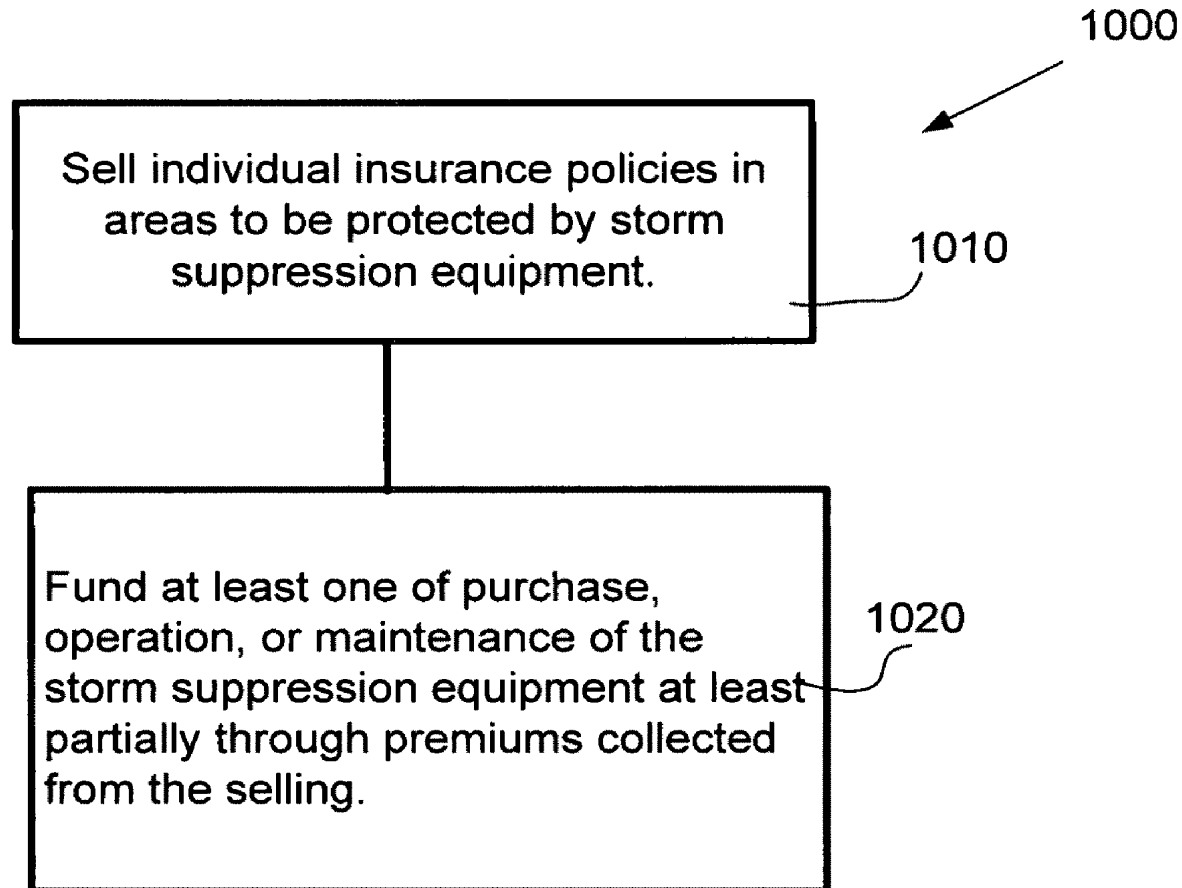

FIG. 11

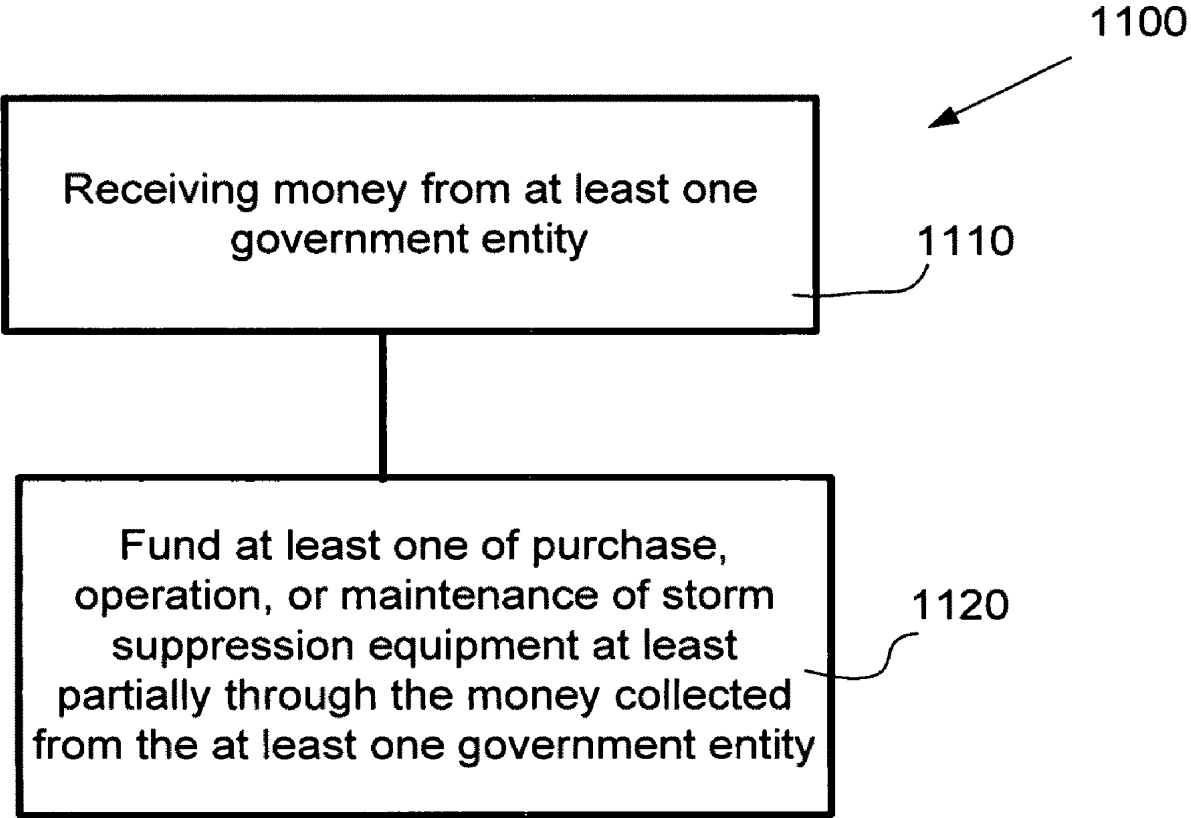

FIG. 12

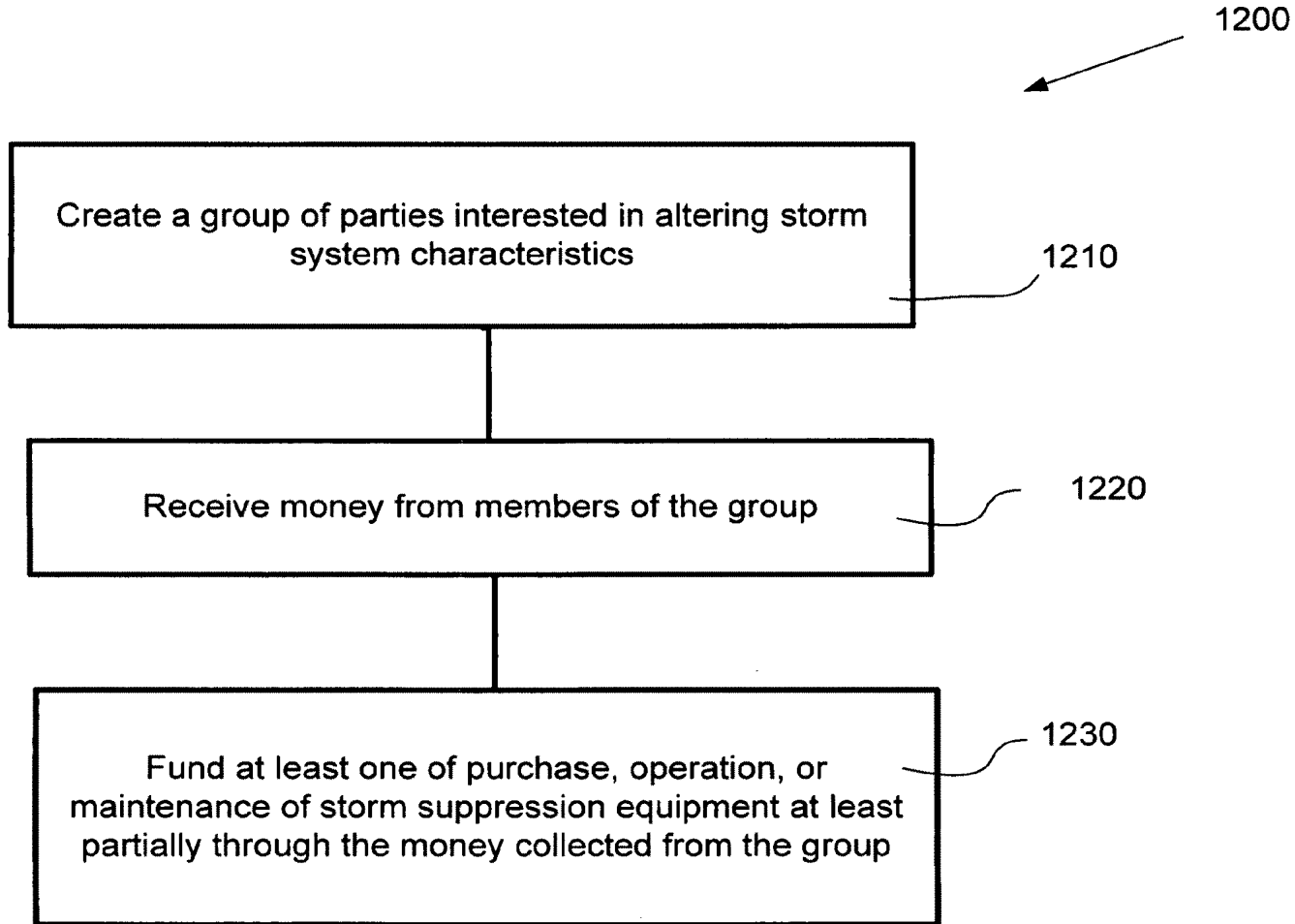

FIG. 13

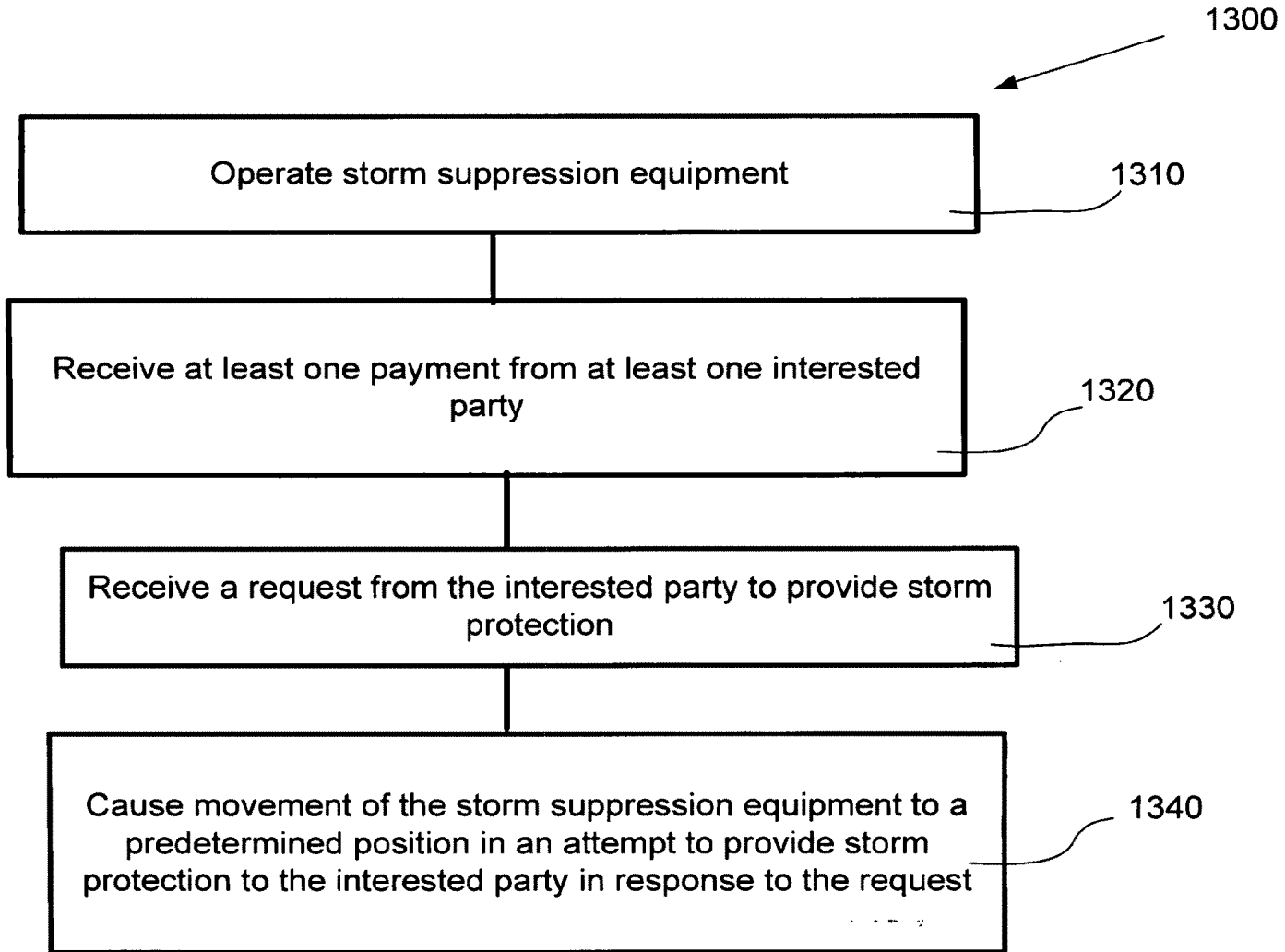
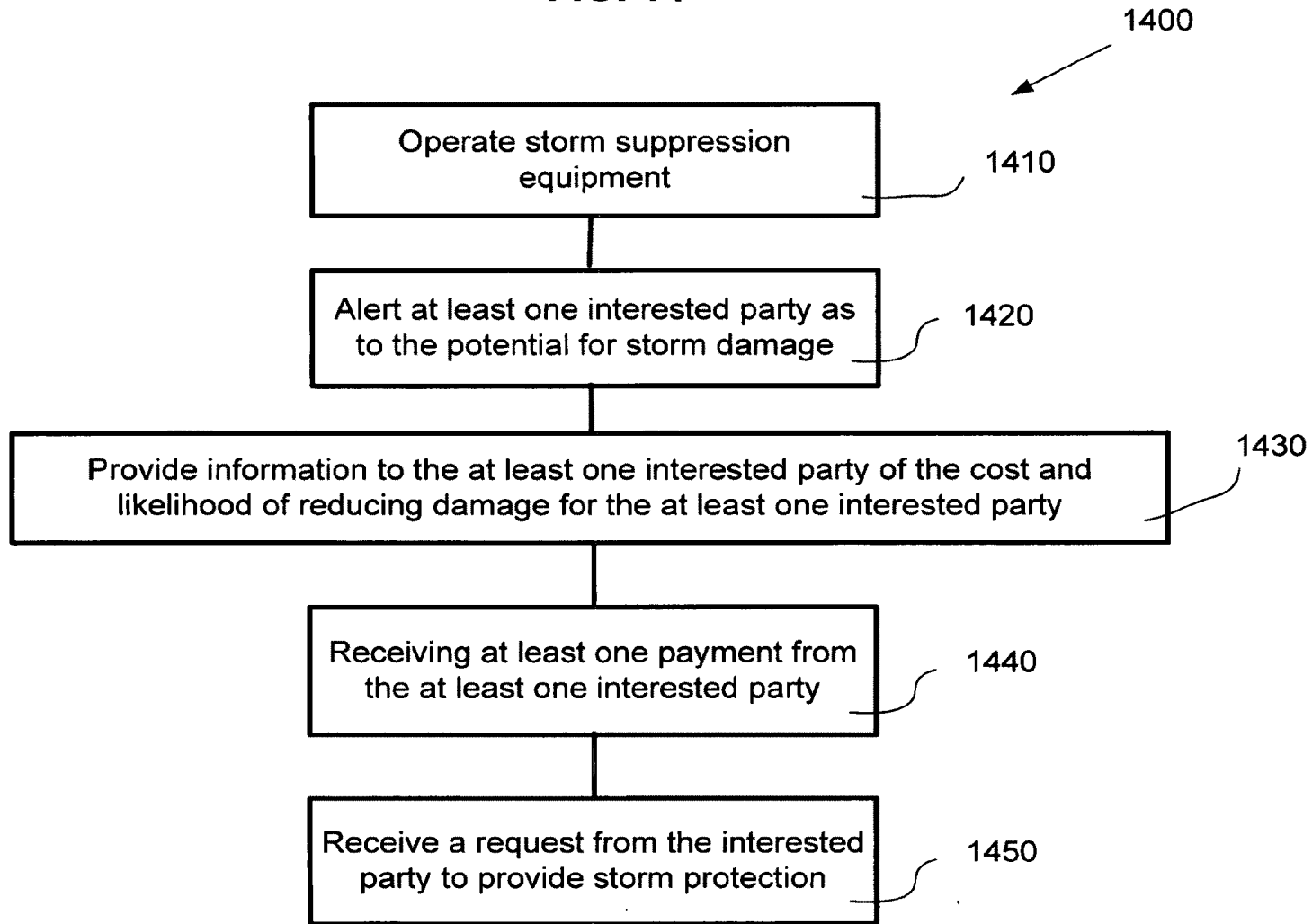

FIG. 14



**WATER ALTERATION STRUCTURE RISK
MANAGEMENT OR ECOLOGICAL
ALTERATION MANAGEMENT SYSTEMS
AND METHODS**

**CROSS-REFERENCE TO RELATED
APPLICATIONS**

[0001] The present application is related to and claims the benefit of the earliest available effective filing date(s) from the following listed application(s) (the "Related Applications") (e.g., claims earliest available priority dates for other than provisional patent applications or claims benefits under 35 USC § 119(e) for provisional patent applications, for any and all parent, grandparent, great-grandparent, etc. applications of the Related Application(s)).

RELATED APPLICATIONS

[0002] For purposes of the USPTO extra-statutory requirements, the present application constitutes a continuation-in-part of U.S. patent application Ser. No. _____ [To Be Assigned by USPTO], entitled WATER ALTERATION STRUCTURE MOVEMENT METHOD AND SYSTEM, naming Jeffrey A. Bowers, Kenneth G Caldeira, Alistair K. Chan, William H. Gates, III, Roderick A. Hyde, Muriel Y. Ishikawa, Jordin T. Kare, John Latham, Nathan P. Myhrvold, Stephen H. Salter, Clarence T. Tegreene, and Lowell L. Wood, Jr. as inventors, filed 3 Jan., 2008, which is currently co-pending, or is an application of which a currently co-pending application is entitled to the benefit of the filing date.

[0003] For purposes of the USPTO extra-statutory requirements, the present application constitutes a continuation-in-part of U.S. patent application Ser. No. _____ [To Be Assigned by USPTO], entitled WATER ALTERATION STRUCTURE APPLICATIONS AND METHODS, naming Jeffrey A. Bowers, Kenneth G Caldeira, Alistair K. Chan, William H. Gates, III, Roderick A. Hyde, Muriel Y. Ishikawa, Jordin T. Kare, John Latham, Nathan P. Myhrvold, Stephen H. Salter, Clarence T. Tegreene, William H. Wattenburg, and Lowell L. Wood, Jr. as inventors, filed 3 Jan., 2008, which is currently co-pending, or is an application of which a currently co-pending application is entitled to the benefit of the filing date.

[0004] For purposes of the USPTO extra-statutory requirements, the present application constitutes a continuation-in-part of U.S. patent application Ser. No. _____ [To Be Assigned by USPTO], entitled WATER ALTERATION STRUCTURE AND SYSTEM, naming Jeffrey A. Bowers, Kenneth C Caldeira, Alistair K. Chan, William H. Gates, III, Roderick A. Hyde, Muriel Y. Ishikawa, Jordin T. Kare, John Latham, Nathan P. Myhrvold, Stephen H. Salter, Clarence T. Tegreene, William H. Wattenburg, Lowell L. Wood and Victoria Y. H. Wood as inventors, filed 3 Jan., 2008, which is currently co-pending, or is an application of which a currently co-pending application is entitled to the benefit of the filing date.

[0005] The United States Patent Office (USPTO) has published a notice to the effect that the USPTO's computer programs require that patent applicants reference both a serial number and indicate whether an application is a continuation or continuation-in-part. Stephen G. Kunin, *Benefit of Prior-Filed Application*, USPTO Official Gazette Mar. 18, 2003, available at <http://www.uspto.gov/web/offices/com/sol/og/2003/week11/patbene.htm>. The present Applicant Entity

(hereinafter "Applicant") has provided above a specific reference to the application(s) from which priority is being claimed as recited by statute. Applicant understands that the statute is unambiguous in its specific reference language and does not require either a serial number or any characterization, such as "continuation" or "continuation-in-part," for claiming priority to U.S. patent applications. Notwithstanding the foregoing, Applicant understands that the USPTO's computer programs have certain data entry requirements, and hence Applicant is designating the present application as a continuation-in-part of its parent applications as set forth above, but expressly points out that such designations are not to be construed in any way as any type of commentary and/or admission as to whether or not the present application contains any new matter in addition to the matter of its parent application(s).

[0006] All subject matter of the Related Applications and of any and all parent, grandparent, great-grandparent, etc. applications of the Related Applications is incorporated herein by reference to the extent such subject matter is not inconsistent herewith.

BACKGROUND

[0007] The description herein generally relates to the field of alteration of water temperatures and dissolved and particulate matter in bodies of water such as oceans, lakes, rivers, structures capable of aiding in the alteration and control of such surface and subsurface water temperatures and compositions as well as controlling the movement of and placement of such structures. The description also generally relates to the field of structures and methods of maintaining water alteration systems.

[0008] Conventionally, there is a need for methods of distributing costs related to altering water properties such that there is a diminished contrast between near surface waters and waters found at greater depth, such as but not limited to atmospheric management, weather management, hurricane suppression, hurricane prevention, hurricane intensity modulation, hurricane deflection, biological augmentation, biological remediation, etc. or generally ecological alteration. There is also a need for managing storm damage risks by using ocean water alteration structures or the like.

SUMMARY

[0009] In one aspect, a method of managing risk includes selling individual insurance policies regarding areas to be protected by storm suppression equipment. The method also includes funding at least one of purchase, operation, or maintenance of the storm suppression equipment at least partially through premiums collected from the selling.

[0010] In another aspect, a method of managing ecological alteration includes receiving money from at least one government entity. The method also includes funding at least one of purchase, operation, or maintenance of ecological alteration equipment at least partially through the money collected from the at least one government entity.

[0011] In a further aspect, a method of managing ecological alteration includes creating a group of parties interested in altering ecological characteristics. The method also includes receiving money from members of the group. Further the method includes funding at least one of purchase, operation, or maintenance of ecological alteration equipment at least partially through the money collected from the group.

[0012] In yet another aspect, a method of managing risk includes operating ecological alteration equipment. The method also includes receiving at least one payment from at least one interested party. Further, the method includes receiving a request from the interested party to provide ecological alteration. Further still, the method includes causing changes in the operation of ecological alteration equipment in an attempt to cause ecological alteration.

[0013] In still yet another aspect, a method of managing risk includes operating storm suppression equipment in response to a request to attempt to alter at least one storm. The method also includes alerting at least one interested party as to the potential for storm damage. Further, the method includes providing information to the at least one interested party of the cost and likelihood of reducing damage for the at least one interested party. Further still, the method includes receiving at least one payment from the at least one interested party and receiving a request from the interested party to provide storm protection.

[0014] In yet still another aspect, a method of managing risk includes selling an interest regarding areas to be protected by ecological alteration equipment to a group of members. The method also includes funding at least one of purchase, operation, or maintenance if the ecological alteration equipment at least partially through payments collected from the selling. Further, the method includes determining the amount of ecological alteration in a predefined situation. Further still, the method includes paying the members of the group an amount dependent on the amount of ecological alteration.

[0015] In addition to the foregoing, other method aspects are described in the claims, drawings, and text forming a part of the present disclosure.

[0016] In one or more various aspects, related systems include but are not limited to circuitry and/or programming for effecting the herein-referenced method aspects; the circuitry and/or programming can be virtually any combination of hardware, software, and/or firmware configured to effect the herein-referenced method aspects depending upon the design choices of the system designer. Also various structural elements may be employed depending on design choices of the system designer.

[0017] In addition to the foregoing, other system aspects are described in the claims, drawings, and text forming a part of the present disclosure.

[0018] In addition to the foregoing, various other method and/or system and/or program product aspects are set forth and described in the teachings such as text (e.g., claims and/or detailed description) and/or drawings of the present disclosure.

[0019] The foregoing is a summary and thus contains, by necessity, simplifications, generalizations and omissions of detail; consequently, those skilled in the art will appreciate that the summary is illustrative only and is NOT intended to be in any way limiting. Other aspects, features, and advantages of the devices and/or processes and/or other subject matter described herein will become apparent in the teachings set forth herein.

BRIEF DESCRIPTION OF THE FIGURES

[0020] The foregoing summary is illustrative only and is not intended to be in any way limiting. In addition to the illustrative aspects, embodiments, and features described above, further aspects, embodiments, and features will

become apparent by reference to the drawings and the following detailed description, of which:

[0021] FIG. 1 is an exemplary diagram of a generalized vessel for holding and moving water.

[0022] FIG. 2 is an exemplary diagram of a pattern of deployment of a plurality of vessels similar to that of FIG. 1.

[0023] FIG. 3 is another exemplary diagram of a pattern of deployment of a plurality of vessels similar to that of FIG. 1.

[0024] FIG. 4 is an exemplary diagram of a generalized vessel for holding and moving water and depicting on-board propulsive devices.

[0025] FIG. 5 is a simplified depiction of a deployment of a plurality of vessels such as those depicted in FIG. 1 in a geographic region, the simplified depiction not intended to imply any specific scale and the depiction of the vessels and watercraft not drawn to scale.

[0026] FIG. 6 is an exemplary block diagram of a generalized vessel for holding and moving water having an auxiliary conduit.

[0027] FIG. 7 is an exemplary diagram of a generalized vessel for holding and moving water being towed by a watercraft.

[0028] FIG. 8 is an exemplary diagram of multiple generalized vessels for holding and moving water being towed by a watercraft.

[0029] FIG. 9 is a process diagram of a method of providing maintenance and entertainment.

[0030] FIG. 10 is a process diagram in accordance with an exemplary embodiment.

[0031] FIG. 11 is a process diagram in accordance with an exemplary embodiment.

[0032] FIG. 12 is a process diagram in accordance with an exemplary embodiment.

[0033] FIG. 13 is a process diagram in accordance with an exemplary embodiment.

[0034] FIG. 14 is a process diagram in accordance with an exemplary embodiment.

DETAILED DESCRIPTION

[0035] In the following detailed description, reference is made to the accompanying drawings, which form a part hereof. In the drawings, similar symbols typically identify similar components, unless context dictates otherwise. The illustrative embodiments described in the detailed description, drawings, and claims are not meant to be limiting. Other embodiments may be utilized, and other changes may be made, without departing from the spirit or scope of the subject matter presented here. Those having skill in the art will recognize that the state of the art has progressed to the point where there is little distinction left between hardware and software implementations of aspects of systems; the use of hardware or software is generally (but not always, in that in certain contexts the choice between hardware and software can become significant) a design choice representing cost vs. efficiency tradeoffs. Those having skill in the art will appreciate that there are various vehicles by which processes and/or systems and/or other technologies described herein can be effected (e.g., hardware, software, and/or firmware), and that the preferred vehicle will vary with the context in which the processes and/or systems and/or other technologies are deployed. For example, if an implementer determines that speed and accuracy are paramount, the implementer may opt for a mainly hardware and/or firmware vehicle; alternatively, if flexibility is paramount, the implementer may opt for a

mainly software implementation; or, yet again alternatively, the implementer may opt for some combination of hardware, software, and/or firmware. Hence, there are several possible vehicles by which the processes and/or devices and/or other technologies described herein may be effected, none of which is inherently superior to the other in that any vehicle to be utilized is a choice dependent upon the context in which the vehicle will be deployed and the specific concerns (e.g., speed, flexibility, or predictability) of the implementer, any of which may vary. Those skilled in the art will recognize that optical aspects of implementations will typically employ optically-oriented hardware, software, and or firmware.

[0036] The foregoing detailed description has set forth various embodiments of the devices and/or processes via the use of block diagrams, flowcharts, and/or examples. Insofar as such block diagrams, flowcharts, and/or examples contain one or more functions and/or operations, it will be understood by those within the art that each function and/or operation within such block diagrams, flowcharts, or examples can be implemented, individually and/or collectively, by a wide range of hardware, software, firmware, or virtually any combination thereof. In one embodiment, several portions of the subject matter described herein may be implemented via Application Specific Integrated Circuits (ASICs), Field Programmable Gate Arrays (FPGAs), digital signal processors (DSPs), or other integrated formats. However, those skilled in the art will recognize that some aspects of the embodiments disclosed herein, in whole or in part, can be equivalently implemented in integrated circuits, as one or more computer programs running on one or more computers (e.g., as one or more programs running on one or more computer systems), as one or more programs running on one or more processors (e.g., as one or more programs running on one or more micro-processors), as firmware, or as virtually any combination thereof, and that designing the circuitry and/or writing the code for the software and or firmware would be well within the skill of one of skill in the art in light of this disclosure. In addition, those skilled in the art will appreciate that the mechanisms of the subject matter described herein are capable of being distributed as a program product in a variety of forms, and that an illustrative embodiment of the subject matter described herein applies regardless of the particular type of signal bearing medium used to actually carry out the distribution. Examples of a signal bearing medium include, but are not limited to, the following: a recordable type medium such as a floppy disk, a hard disk drive, a Compact Disc (CD), a Digital Video Disk (DVD), a digital tape, a computer memory, etc.; and a transmission type medium such as a digital and/or an analog communication medium (e.g., a fiber optic cable, a waveguide, a wired communications link, a wireless communication link, etc.). Further, those skilled in the art will recognize that the mechanical structures disclosed are exemplary structures and many other forms and materials may be employed in constructing such structures.

[0037] The need for mechanisms, devices, methods, systems, and structures which may be used to alter hurricanes either in their strength, their origin, or their direction of travel has been realized. Billions of dollars of destruction and damage is regularly attributable to hurricanes and hurricane-like tropical storms. Thus, great interest has arisen in controlling these powerful storms. Conventionally, it has been proposed to deploy barges equipped with upward-pointing jet engines into the paths of hurricanes. The jet engines would theoretically be configured to create mini-cyclones which would

consume oceanic energy and thus prevent or suppress such high powered weather systems.

[0038] Another potential solution involves the use of Dyno-O-Gel, a polymer that may absorb as much as 1,500 times its own weight in water to deprive a hurricane of atmospheric moisture. The concept involves the use of airplanes to drop Dyno-O-Gel into hurricanes to deprive them of moisture and thus of latent heat. The powder is suggested to convert into a gel when the atmospheric moisture is captured and would then reliquify when it encounters higher-osmolality ocean water.

[0039] The jet engine solution has been met with great skepticism and the cost and feasibility are very uncertain. The use of a moisture absorbing gel requires the deployment of a huge volume of the absorbing gel material. Also, the use of a moisture absorbing material is still in the testing phase. The gel material after absorbing moisture falls to the ocean and may dissolve. Depending on the chemical composition of the gel, the gel be regarded as a pollutant. These various shortcomings considered, it may be desirable to provide a different approach for altering hurricane and/or tropical storm activity by providing a structure and method that solves at least one or more deficiencies of other systems known in the art. Because hurricanes and other tropical storms derive their energy from warm ocean water, it is logical to harness the great energies of the Earth's fluid envelopes to suppress or alter hurricanes or other tropical storms, and/or to employ the powers of motion within these envelopes over long time-intervals to modulate at least one property of an envelope that is exploited over much shorter time-scales and/or much more limited spatial scales for energizing a hurricane.

[0040] A potential solution for cooling warm surface water has been explored by researchers with Atmocean, Inc. of Santa Fe, N. Mex. In the Atmocean approach, an elongated tube with a buoy is used to create an upwelling effect. The upwelling effect drives cold water from a depth to the surface.

[0041] It is well known that a hurricane's primary energy source is the release of the heat of condensation of water vapor condensing at high altitudes, with solar-derived heat being the initial source for evaporation. Therefore, a hurricane may be seen as a giant vertical heat engine, albeit one dependent upon mass supplied by largely horizontal flows. Water condensation leads to higher wind speeds, as a fraction of the released energy is converted immediately into thermal energy and thence into mechanical energy, the faster winds and lower pressures associated with them in turn cause increased surface evaporation and thus even more subsequent condensation. Much of the released energy drives updrafts that increase the height of speeding up condensation. This gives rise to factors that provide the system with enough energy to be self-sustaining, and result in a positive feedback loop that continues as long as the tropical cyclone can draw energy from a thermal reservoir and isn't excessively sheared along its vertical extent. In this case, the heat source is the warm water at the surface of the ocean. Without this thermal reservoir to support it a hurricane or other similar storm will not commence, will be weaker, or will die out as the positive feedback loop diminishes to sub-threshold levels or never gets above them.

[0042] Referring now to FIG. 1, a cross-section of a water-borne structure or vessel **100** is depicted. Vessel **100** is a tub-like structure having one or more walls **110** and a bottom **115**. Vessel **100** may be held buoyant in the water by one or more buoyancy tanks **120** which may be used to maintain the

buoyancy of vessel 100 and further may be used to control the height of walls 110 above the water level. Vessel 100 also includes a conduit 125 whose horizontal cross section is substantially smaller than the horizontal cross section of the tub portion 130 of the vessel defined by walls 110. In an exemplary embodiment, conduit 125 extends well below the ocean surface including depths below the ocean's thermocline.

[0043] In most circumstances, most of the sunlight impinging on the ocean surface is absorbed in the surface layer. The surface layer therefore heats up. Wind and waves move water in this surface layer which distributes heat within it. The temperature may therefore be reasonably uniform to depths extending a few hundred feet down from the ocean surface. Below this mixed layer, however, the temperature decreases rapidly with depth, for example, as much as 20 degrees Celsius with an additional 150 m (500 ft) of depth. This area of rapid transition is called the thermocline. Below it, the temperature continues to decrease with depth, but far more gradually. In the Earth's oceans, approximately 90% of the mass of water is below the thermocline. This deep ocean consists of layers of substantially equal density, being poorly mixed, and may be as cold as -2 to 3° C.

[0044] Therefore, the lower depths of the ocean may be used as a huge heat/energy sink which may be exploited by vessel 100. When vessel 100 is deployed at sea, waves 135 may lap over the top of walls 110 to input warm (relative to deeper waters) surface ocean water into tub 130. Tub 130 will fill to a level 140 which is above the average ocean level depicted as level 145. Because of the difference between levels 140 and 145, a pressure head is created thereby pushing warm surface ocean water in a downward direction 150 down through conduit 125 to exit into the cold ocean depths (relative to near surface waters) through one or more openings 155. In an exemplary embodiment, the depth of opening 155 may be located below the ocean's thermocline, the approximate bottom of which is depicted as line 160. This cycle will be continuous in bringing warm surface ocean water to great depth as ocean waves continue to input water into tub 130.

[0045] If many of vessel 100 are distributed throughout a region of water, the temperature of the surface of the water may be altered. Referring to FIG. 2, an array 200 of vessels 100 is depicted. Such vessels may be arranged in a plurality of ways, including but not limited to positioning them in a water region in an array, such as array 200, in a random placement 300 as depicted in FIG. 3 within a region, and/or in any other arrangement. It may be desirable to determine the most suitable and/or optimal arrangements through computer modeling or other techniques. Referring now to FIG. 5, it may be seen that many vessels 100 may be dispersed throughout hurricane prone regions such as but not limited to the Gulf of Mexico 500 or the Caribbean Sea. Vessels 100, depicted for illustrative purposes only and not to scale are shown being dispersed in a relatively random pattern. Boats 510 may be used to tow vessels to desired locations. Also, other means such as self propulsion, airlifting, towing, or other methods to move vessels may also be used. In another embodiment, vessels 100 may be anchored in a variety of ways, including but not limited to anchored to the bottom, anchored using subsurface weights, anchored using sea anchors, or anchored to each other.

[0046] Referring now to FIG. 7, a group 700 of holding vessels 100 is depicted in a path, approximately defined by lines 720, of a storm 710. Storm 710 may include many of a

variety of atmospheric or oceanic disturbances, such as but not limited to a tropical depression, a tropical storm, a low pressure atmospheric disturbance, a predicted storm, a hurricane, or a typhoon (tropical cyclone). As described above, such disturbances derive energy from warm surface water, therefore by producing a change in the surface temperature of the oceanic region within a path 720 of the storm 710, storm 710 may be affected by being diminished in energy, by being deflected, by being destroyed, etc. Through weather prediction techniques, the path 720 of disturbance 710 may be determined and vessels 100 may be moved into the path 720 of storm 710 by using watercraft 510 (or by using other techniques) to move vessels 100 into desired placements or positions. In one exemplary embodiment, coastline 730 may be desired to be protected. Coastline 730 may include beaches, communities, buildings, etc. which may be desired to be protected from strong storms, winds, storm surges, and the like.

[0047] Referring again to FIG. 1 vessel 100 may be one vessel in a system for altering water surface temperature. As such the tub 130 is one type of a holding vessel configured to hold water. Tub 130 includes at least one wall 110 (but may include multiple walls) which are coupled to a bottom portion 115. The at least one wall 110 extends above the water level and the bottom portion 115 is configured to be submerged. At least one conduit 125 extends from the bottom of the tub 130. In some, but not necessarily all, applications, it may be desirable for conduit 125 to have a length that extends to a depth at which the temperature of water at the depth (e.g., below line 160) is substantially less than water at the surface

[0048] Vessel 100 may be held buoyant by both the materials used to construct vessel 100 as well as at least one ballast tank 120. Tanks 120 may be coupled to at least one pump 170 and at least one valve 180. In accordance with an exemplary embodiment, the height of wall 110 above the average water surface level may be varied and controlled depending on the time-varying height of the local waves and depending on the desired flow rate through conduit 125. One way in which to vary the height of wall 110 above the average water level 145 is to pump atmospheric air into tank 120 or out of tank 120. In conjunction with pump 170, valve 180 may be used to draw water into or out of tanks 120. In accordance with another exemplary embodiment, it may be desirable to have the ability to mechanically raise or lower at least a portion of wall 110 relative to the rest of the structure. It may also be desirable to control the raising and lowering of all or part of wall 110 in response to conditions adjacent to vessel 100 (e.g., water temperature, wave height).

[0049] In another embodiment, water flow into vessel 100 may be via openings 175 in wall 110, rather than over the top of wall 110. Such openings may be configured to preferentially allow flow into vessel 100, instead of out of the vessel. In some embodiments, openings 175 are passive, using flaps, checkvalves, rotating drums, or similar mechanisms to support unidirectional flow. In other embodiments, openings 175 are actively controlled, utilizing motorized or variable set-point flow control devices such as valves, flaps, rotating drums, or similar mechanisms.

[0050] Walls 110 and bottom portion 115 as well as other parts of vessel 100 may be constructed of any of a variety of materials and preferably of a material substantially resistant to degradation in water. For example, vessel 110 may be substantially constructed from concrete, polymers, at least one of metals or metal alloys, fabrics, reinforced fabrics,

and/or composite materials. In some applications, it may be advantageous for the construction materials to resist degradation only for a limited period of time, as degradation of the structure may diminish or eliminate expenditures associated with post-application retrieval of the structure. Furthermore, it may be advantageous to allow the structure to sink below the water surface or to the water bottom after application, where degradation may be preferred to occur. In an exemplary embodiment, conduit 125 may be formed of any of a variety of materials including both rigid materials and flexible materials. It may also be desirable to use stiffening structures in the conduit depending on the type of materials used. Such stiffening structures aid in maintaining the shape of conduit 125 under pressure and under stress. The stiffening structures may be placed at one or more locations along the length of the conduit. Further, such stiffening structures may be deployable and may aid in deployment along with a conduit which may also be deployable from tub 130. In yet another exemplary embodiment, it may be desirable to form vessel 100 from a material which would be known to degrade over time. This may be useful if it is known that a vessel has a desired lifespan or term of usefulness. Once the vessel's use is done, the vessel could sink or be sunk where it could subsequently degrade at a subsurface location.

[0051] In an exemplary embodiment the holding vessel or tub 110 has a horizontal cross sectional dimension that is substantially greater than a horizontal cross sectional dimension of the conduit 125. In another exemplary embodiment holding vessel or tub 100 has a horizontal cross sectional dimension and/or shape that is substantially the same as the cross sectional dimension and/or shape as conduit 125. The pressure head created by the weight of the column of water above the conduit which is above the line 145 is used to pressurize the descending water in conduit 125. In an exemplary embodiment it may be convenient to have a power source 190 on board vessel 100. Power source 190 may be any of a variety of power sources, including but not limited to a solar cell, a wind generator, a wave power generator, a turbine turned by water descending in the conduit, a battery power source, a fuel powered power source, a thermoelectric power source, etc.

[0052] In accordance with an embodiment a vessel 600 is depicted in FIG. 6 having a conduit 625. Disposed within conduit 625 is a turbine 630. Turbine 630 may be driven by the flow of water through conduit 625. Turbine 630 may be utilized for a variety of purposes including but not limited to generating power for a variety of purposes, maintaining buoyancy, controlling buoyancy, driving other turbines, increasing the water flow through conduit 625, etc.

[0053] In accordance with other exemplary embodiments it may be desirable to equip vessel 100 with one or more propulsion systems. Referring now to FIG. 4, a propulsion system may be in the form of a sail or a propeller 450 or other motorized propulsion producing device. Such a propulsive device may be powered by power source 460 or any other source of power. The propulsion system may be used to control the positioning of vessel 100 such that it remains at a specific area, moves in a specific pattern, and/or moves to a completely new location. A rudder 470, fin, sail, or other steering device may be coupled to vessel 100 to help guide vessel 100. Alternatively, a sail or a propeller 450 may be configured to change orientation to provide steering for vessel 100. Because different depths in bodies of water often have currents flowing in different directions or with different

speeds, a propulsion system may involve the use of one or more sea anchors with mechanisms and control systems to effect proper placement of the sea anchors. In one exemplary embodiment, it may be desirable to construct vessel 100 with a shape such that its coefficient of drag is less in one direction than another. This may be accomplished by making the dimensions of vessel 100 longer in one direction than another, for example. Other methods and shapes may also be used to produce such an effect.

[0054] In accordance with another exemplary embodiment, vessel 100 may include a movable conduit in which at least a portion 480 of conduit 425 may be movable in various directions in order to provide a propulsive force in a desired direction. In another exemplary embodiment, the movable portion may be one or more openings 455 which may be controlled, along the length of conduit 425. The propulsive force generated by water flow through conduit 425 may also be varied by opening and closing opening 485 using a controlled access device such as door 490 (or other aperture control devices such as but not limited to valves, etc.) that may control the flow rate through conduit 425.

[0055] In an exemplary embodiment walls 410 of vessel 100 may be formed of multiple wall segments or multiple wall portions. The multiple wall segments of walls 410 form a closed shape to contain water within vessel 100. The wall segments may be curved or straight, may be movable in such a way as to help let in water or alternatively to release water. In one exemplary embodiment, vessel 100 may be permanently anchored to the water floor, temporarily anchored to the water floor, tied to a subsurface weight, tied to one or more sea-anchors, or may be freely movable. In one exemplary embodiment, vessel 100 is movable by coupling the vessel to a propulsive vessel, such as a tugboat or the like. In another exemplary embodiment, vessel 100 may include a wind capture structure, such as a sail 495 that may be used to harness wind power for moving the holding vessel. The wind capture structure may be used for controlling the amount that the at least one wall of the holding vessel extends above the water, that is it may also be used to provide lift to the holding vessel 100 structure, to help control how far above the water level that walls 410 extend. Sea anchors are functionally similar to sails, except instead of extending up into the atmosphere they are deployed into the water. Thus, sea anchors or current capture structures may be used for similar purposes as sails and wind capture structures. These include moving or holding the vehicle, generating power, providing lift, etc. Also in an exemplary embodiment, vessel 100 may have a ramp area 475 or other wave altering area that helps to control how the waves move water over the sides of vessel 100. This wave-altering structure may be a static or passive structure, or it may be an active device or structure having one or more components that are actuated or powered in order to have a time-dependent character or activity; the power for such purposes may be derived from any of the power-providing means discussed above, or may be derived from the wave-action itself. Further, in an exemplary embodiment, vessel 100 may have any of a variety of shapes including but not limited to circular, elongated, non-circular, shaped in a manner which aids in passively controlling orientation relative to wave motion, etc.

[0056] Referring now to FIG. 6, a vessel 600 is depicted. Vessel 600 includes a conduit 625 in which a turbine 630 is driven by the downward flow of water through conduit 625. In an exemplary embodiment, the turning turbine may be used for a variety of purposes including providing electric or

mechanical power, providing control, providing propulsive power, etc. In one exemplary embodiment a secondary conduit **640** (which represents one or more conduits) may be used to bring cold water (such as below an ocean thermocline **650**) to upper areas of warmer surface water to aid in cooling the warm surface water regions, enhance mixing of subsurface water with surface water, enhance mixing of surface water with subsurface water, raising subsurface nutrients to the surface, bringing surface nutrients to subsurface regions, etc. In one exemplary embodiment, turbine **630** may be used to drive a second turbine **635** in conduit **640** that pumps water up through conduit **640**. Further, other mechanisms may be used to bring subsurface water upwards. In most places, deeper waters contain a greater concentration of nutrients than surface water, so conduit **640** may also be used to transport dissolved nutrients from deeper waters to waters near the surface of the body of water.

[0057] Referring now to FIG. 8, a vessel **100** as depicted in FIG. 1 is depicted having conduit **125** outlet **155** adjacent the floor **195** of a body of water (ocean, lake, sea, etc.). Water flowing out of outlet **155** may be used to cause turbidity near floor **195** by stirring up sediment from the bottom. Some of this sediment may include food or other nutrients which may encourage plant and animal growth. Also, nutrients and warm water may be brought from the surface also aiding in stimulating plant and animal growth. Thus, by the placement of one or more vessels **100** in a particular location, plant and animal life may be encouraged. This may be used for developing wildlife preservation areas, wildlife recreation areas, restoring wildlife destroyed by natural or man-made causes, etc.

[0058] Referring now to FIG. 9, a method **900** of environmental alteration includes determining a placement of at least one vessel capable of moving water adjacent the surface of the water to a lower depth in the water (process **910**). The method also includes placing the at least one vessel in the determined placement, location, and/or arrangement (process **920**). Further, the method includes generating movement of the water adjacent the surface of the water in response to the placing (process **930**). The movement is caused once a sufficient pressure head has been developed to cause a downward flow of surface waters through the conduit of the water alteration vessel. In accordance with an alternative embodiment, a method of environmental alteration includes determining an application of at least one vessel that is capable of moving water adjacent the surface of the water to a lower depth in the water primarily using a developed pressure head in the vessel (process **940**). The method also includes placing the at least one vessel in the determined placement (process **920**) and generating movement of the water adjacent the surface of the water based on the application (process **930**).

[0059] Referring now to FIG. 10, a method of managing risk **100** is depicted. Method **1000** includes but is not limited to selling individual insurance policies in areas to be protected by storm suppression equipment (process **1010**). The selling may be done by regular insurance companies, reinsurers, companies that make, distribute, install, or sell storm suppression equipment, companies which manage, operate, or run storm suppression equipment, governments, among others. Method **1000** also includes funding at least one of purchase, operation, or maintenance of the storm suppression equipment at least partially through premiums collected from the selling (process **1020**). The selling may be to businesses, to governmental entities, to individuals, among others. An alternative part of method **1000** may be to create different risk

zones based on a known placement of at least some of the storm suppression equipment. This may be done as an effective way to manage the financial, advertising, and/or public relations for the system, as well as managing operations, among other things. Also, different premiums based on location relative to the zones may be developed using actuarial models and techniques. Further, different premiums may be derived based on potential property risk.

[0060] In accordance with exemplary embodiments, the storm suppression equipment may be used to aid in suppressing tropical storms, suppressing hurricanes, etc. The storm suppression equipment may include some form of water alteration equipment, ocean water alteration equipment, water temperature alteration equipment, and/or cloud seeding equipment, or the like.

[0061] Referring now to FIG. 11, a method of managing risk **1100** is depicted. Method **1100** includes receiving money from at least one government entity (process **1110**). Method **1100** also includes funding at least one of purchase, operation, or maintenance of storm suppression equipment at least partially through the money collected from the at least one government entity (process **1120**). In accordance with an exemplary embodiment, the government entity may include but is not limited to a federal government agency, a state government entity, a county government entity, a city government entity, among others.

[0062] Referring now to FIG. 12, a method **1200** of managing risk includes creating a group of parties interested in altering storm system characteristics (process **1210**). Method **1200** also includes receiving money from members of the group (process **1220**). Method **1200** further includes funding at least one of purchase, operation, or maintenance of storm suppression equipment at least partially through the money collected from the group (process **1230**). In one exemplary embodiment an interest may be sold to businesses, to governmental entities, to individuals, etc.

[0063] Referring now to FIG. 13, a method of managing risk **1300** includes operating storm suppression equipment (process **1310**). Method **1300** also includes receiving at least one payment from at least one interested party (process **1320**). Further, method **1300** includes receiving a request from the interested party to provide storm protection (process **1330**). Further still, method **1300** includes causing movement of the storm suppression equipment to a predetermined position in an attempt to provide storm protection to the interested party in response to the request (process **1340**).

[0064] In accordance with a method of managing risk **1400** of FIG. 14, method **1400** includes operating storm suppression equipment (process **1410**). Method **1400** also includes alerting at least one interested party as to the potential for storm damage (process **1420**). Method **1400** further includes providing information to the at least one interested party of the cost and likelihood of reducing damage for the at least one interested party (process **1430**). Method **1400** further includes receiving at least one payment from the at least one interested party (process **1440**) and receiving a request from the interested party to provide storm protection (process **1450**).

[0065] In accordance with an alternative embodiment, method **1400** may also include developing a movement plan that can be implemented in moving the holding vessels to desired locations. Method **1400** may also include developing a control plan which can be used to maintain control of the holding vessels and used to define and carry out objectives.

[0066] The capability of the systems and methods described to enhance mixing between surface and subsurface water can be useful for other applications in addition to thermally based weather modification. One such application is to aid in ocean uptake of atmospheric CO₂. Oceans are natural CO₂ sinks, and represent the largest active carbon sink on Earth. This role as a sink for CO₂ is driven by two processes, the solubility pump and the biological pump. The former is primarily a function of differential CO₂ solubility in seawater and the thermohaline circulation, while the latter is the sum of a series of biological processes that transport carbon (in organic and inorganic forms) from the near-surface euphotic zone to the ocean's interior.

[0067] The solubility pump is a nonbiological effect wherein CO₂ first dissolves in the surface layer of the ocean. This surface layer can become saturated and its ability to absorb more carbon dioxide declines. Use of this system to promote mixing between surface and subsurface water enhances the efficacy of solubility pump in at least two manners; by net transport of CO₂-enriched water downwards, as well as by reducing the temperature of the surface water, thereby increasing its ability to dissolve CO₂. The solubility pump enhancement induced by this system can also be useful for increasing ocean uptake of other atmospheric gases, such as methane, nitrogen oxides, sulfur dioxide, etc.

[0068] While the biological pump currently has a limited effect on uptake of CO₂ introduced into the atmosphere by human activities, there have been suggestions to increase the carbon sequestration efficiency of the oceans by increasing the surface-layer phytoplankton concentration, which is in many instances limited by insufficient surface-layer nutrients. Nitrates, silicates, and phosphates are, for instance, largely absent from surface waters, yet are considerably more abundant in subsurface oceans. These exemplary systems and methods can be used to mix surface and subsurface waters, thereby transporting nutrients towards the surface. This increase in surface nutrients can be useful in increasing the CO₂ biological pump by increasing surface-layer phytoplankton concentrations. Increases in surface-layer nutrients can also be useful for increasing populations of water-based fauna or flora, both in oceans and in other water bodies, such as lakes, reservoirs, rivers, etc.

[0069] The benefits of these systems and methods in increasing mixing between surface and subsurface water is not restricted to use in oceans, but can also be beneficial in other bodies of water, such as lakes, reservoirs, rivers, etc.

[0070] In a general sense, those skilled in the art will recognize that the various embodiments described herein can be implemented, individually and/or collectively, by various types of electro-mechanical systems having a wide range of electrical components such as hardware, software, firmware, or virtually any combination thereof; and a wide range of components that may impart mechanical force or motion such as rigid bodies, spring or torsional bodies, hydraulics, and electro-magnetically actuated devices, or virtually any combination thereof. Consequently, as used herein "electro-mechanical system" includes, but is not limited to, electrical circuitry operably coupled with a transducer (e.g., an actuator, a motor, a piezoelectric crystal, etc.), electrical circuitry having at least one discrete electrical circuit, electrical circuitry having at least one integrated circuit, electrical circuitry having at least one application specific integrated circuit, electrical circuitry forming a general purpose computing device configured by a computer program (e.g., a general

purpose computer configured by a computer program which at least partially carries out processes and/or devices described herein, or a microprocessor configured by a computer program which at least partially carries out processes and/or devices described herein), electrical circuitry forming a memory device (e.g., forms of random access memory), electrical circuitry forming a communications device (e.g., a modem, communications switch, or optical-electrical equipment), and any non-electrical analog thereto, such as optical or other analogs. Those skilled in the art will also appreciate that examples of electro-mechanical systems include but are not limited to a variety of consumer electronics systems, as well as other systems such as motorized transport systems, factory automation systems, security systems, and communication/computing systems. Those skilled in the art will recognize that electro-mechanical as used herein is not necessarily limited to a system that has both electrical and mechanical actuation except as context may dictate otherwise.

[0071] In a general sense, those skilled in the art will recognize that the various aspects described herein which can be implemented, individually and/or collectively, by a wide range of hardware, software, firmware, or any combination thereof can be viewed as being composed of various types of "electrical circuitry." Consequently, as used herein "electrical circuitry" includes, but is not limited to, electrical circuitry having at least one discrete electrical circuit, electrical circuitry having at least one integrated circuit, electrical circuitry having at least one application specific integrated circuit, electrical circuitry forming a general purpose computing device configured by a computer program (e.g., a general purpose computer configured by a computer program which at least partially carries out processes and/or devices described herein, or a microprocessor configured by a computer program which at least partially carries out processes and/or devices described herein), electrical circuitry forming a memory device (e.g., forms of random access memory), and/or electrical circuitry forming a communications device (e.g., a modem, communications switch, or optical-electrical equipment). Those having skill in the art will recognize that the subject matter described herein may be implemented in an analog or digital fashion or some combination thereof.

[0072] Those skilled in the art will recognize that it is common within the art to implement devices and/or processes and/or systems in the fashion(s) set forth herein, and thereafter use engineering and/or business practices to integrate such implemented devices and/or processes and/or systems into more comprehensive devices and/or processes and/or systems. That is, at least a portion of the devices and/or processes and/or systems described herein can be integrated into other devices and/or processes and/or systems via a reasonable amount of experimentation. Those having skill in the art will recognize that examples of such other devices and/or processes and/or systems might include—as appropriate to context and application—all or part of devices and/or processes and/or systems of (a) an air conveyance (e.g., an airplane, rocket, hovercraft, helicopter, etc.), (b) a ground conveyance (e.g., a car, truck, locomotive, tank, armored personnel carrier, etc.), (c) a building (e.g., a home, warehouse, office, etc.), (d) an appliance (e.g., a refrigerator, a washing machine, a dryer, etc.), (e) a communications system (e.g., a networked system, a telephone system, a Voice over IP system, etc.), (f) a business entity (e.g., an Internet Service Provider (ISP)

entity such as Comcast Cable, Quest, Southwestern Bell, etc), or (g) a wired/wireless services entity such as Sprint, Cingular, Nextel, etc.), etc.

[0073] One skilled in the art will recognize that the herein described components (e.g., steps), devices, and objects and the discussion accompanying them are used as examples for the sake of conceptual clarity and that various configuration modifications are within the skill of those in the art. Consequently, as used herein, the specific exemplars set forth and the accompanying discussion are intended to be representative of their more general classes. In general, use of any specific exemplar herein is also intended to be representative of its class, and the non-inclusion of such specific components (e.g., steps), devices, and objects herein should not be taken as indicating that limitation is desired.

[0074] With respect to the use of substantially any plural and/or singular terms herein, those having skill in the art can translate from the plural to the singular and/or from the singular to the plural as is appropriate to the context and/or application. The various singular/plural permutations are not expressly set forth herein for sake of clarity.

[0075] The herein described subject matter sometimes illustrates different components contained within, or connected with, different other components. It is to be understood that such depicted architectures are merely exemplary, and that in fact many other architectures can be implemented which achieve the same functionality. In a conceptual sense, any arrangement of components to achieve the same functionality is effectively “associated” such that the desired functionality is achieved. Hence, any two components herein combined to achieve a particular functionality can be seen as “associated with” each other such that the desired functionality is achieved, irrespective of architectures or intermedial components. Likewise, any two components so associated can also be viewed as being “operably connected”, or “operably coupled”, to each other to achieve the desired functionality, and any two components capable of being so associated can also be viewed as being “operably couplable”, to each other to achieve the desired functionality. Specific examples of operably couplable include but are not limited to physically mateable and/or physically interacting components and/or wirelessly interactable and/or wirelessly interacting components and/or logically interacting and/or logically inter-actable components.

[0076] While particular aspects of the present subject matter described herein have been shown and described, it will be apparent to those skilled in the art that, based upon the teachings herein, changes and modifications may be made without departing from the subject matter described herein and its broader aspects and, therefore, the appended claims are to encompass within their scope all such changes and modifications as are within the true spirit and scope of the subject matter described herein. Furthermore, it is to be understood that the invention is defined by the appended claims. It will be understood by those within the art that, in general, terms used herein, and especially in the appended claims (e.g., bodies of the appended claims) are generally intended as “open” terms (e.g., the term “including” should be interpreted as “including but not limited to,” the term “having” should be interpreted as “having at least,” the term “includes” should be interpreted as “includes but is not limited to,” etc.). It will be further understood by those within the art that if a specific number of an introduced claim recitation is intended, such an intent will be explicitly recited in the claim, and in the absence of such

recitation no such intent is present. For example, as an aid to understanding, the following appended claims may contain usage of the introductory phrases “at least one” and “one or more” to introduce claim recitations. However, the use of such phrases should not be construed to imply that the introduction of a claim recitation by the indefinite articles “a” or “an” limits any particular claim containing such introduced claim recitation to inventions containing only one such recitation, even when the same claim includes the introductory phrases “one or more” or “at least one” and indefinite articles such as “a” or “an” (e.g., “a” and/or “an” should typically be interpreted to mean “at least one” or “one or more”); the same holds true for the use of definite articles used to introduce claim recitations. In addition, even if a specific number of an introduced claim recitation is explicitly recited, those skilled in the art will recognize that such recitation should typically be interpreted to mean at least the recited number (e.g., the bare recitation of “two recitations,” without other modifiers, typically means at least two recitations, or two or more recitations). Furthermore, in those instances where a convention analogous to “at least one of A, B, and C, etc.” is used, in general such a construction is intended in the sense one having skill in the art would understand the convention (e.g., “a system having at least one of A, B, and C” would include but not be limited to systems that have A alone, B alone, C alone, A and B together, A and C together, B and C together, and/or A, B, and C together, etc.). In those instances where a convention analogous to “at least one of A, B, or C, etc.” is used, in general such a construction is intended in the sense one having skill in the art would understand the convention (e.g., “a system having at least one of A, B, or C” would include but not be limited to systems that have A alone, B alone, C alone, A and B together, A and C together, B and C together, and/or A, B, and C together, etc.). It will be further understood by those within the art that virtually any disjunctive word and/or phrase presenting two or more alternative terms, whether in the description, claims, or drawings, should be understood to contemplate the possibilities of including one of the terms, either of the terms, or both terms. For example, the phrase “A or B” will be understood to include the possibilities of “A” or “B” or “A and B.”

[0077] While various aspects and embodiments have been disclosed herein, other aspects and embodiments will be apparent to those skilled in the art. The various aspects and embodiments disclosed herein are for purposes of illustration and are not intended to be limiting, with the true scope and spirit being indicated by the following claims.

1. A method of managing risk, comprising:
 - selling insurance policies regarding areas to be protected by storm suppression equipment, the storm suppression equipment including wave driven water temperature alteration equipment; and
 - funding at least one of purchase, operation, or maintenance of the storm suppression equipment at least partially through premiums collected from the selling.
2. The method of claim 1, wherein the selling includes selling to at least one of businesses, governmental entities, individuals, or insurance companies.
- 3-5. (canceled)
6. The method of claim 1, further comprising:
 - creating different risk zones based on a known placement of at least some of the storm suppression equipment.
7. The method of claim 1, further comprising:

- creating different risk zones based on a known placement of at least some of the storm suppression equipment; and developing actuarially different premiums based on location relative to the zones.
- 8.** The method of claim **1**, further comprising: developing actuarially different premiums based on potential property risk.
- 9.** The method of claim **1**, wherein the storm suppression equipment may be used to aid in suppressing tropical storms.
- 10.** The method of claim **1**, wherein the storm suppression equipment may be used to aid in suppressing hurricanes.
- 11-14.** (canceled)
- 15.** A method of ecological alteration, comprising: receiving money from at least one government entity; and funding at least one of purchase, operation, or maintenance of ecological alteration equipment at least partially through the money collected from the at least one government entity, wherein the ecological alteration equipment includes wave driven water property alteration equipment.
- 16.** The method of claim **15**, wherein money is received from at least one of a group of government entities a federal government agency, a state government entity a county government entity, or a city government entity.
- 17-20.** (canceled)
- 21.** The method of claim **15**, further comprising: creating different risk or reward zones based on a known placement of the ecological alteration equipment.
- 22.** The method of claim **15**, further comprising: creating different risk or reward zones based on a known placement of the ecological alteration equipment; and developing different payment amounts based on location relative to the risk zones.
- 23.** The method of claim **15**, further comprising: developing different payment amounts based on at least one of potential property risk or potential change in property valuation.
- 24.** The method of claim **15**, further comprising: developing different payment amounts based on location.
- 25.** The method of claim **15**, wherein the ecological alteration equipment is designed to suppress tropical storms.
- 26.** The method of claim **15**, wherein the ecological alteration equipment is designed to suppress hurricanes.
- 27-30.** (canceled)
- 31.** The method of claim **15**, wherein the ecological alteration equipment comprises storm course alteration equipment.
- 32.** The method of claim **15**, wherein the ecological alteration equipment comprises biological alteration equipment.
- 33.** The method of claim **15**, wherein the ecological alteration equipment comprises biological augmentation equipment.
- 34.** A method of ecological alteration, comprising: creating a group of parties interested in altering ecological characteristics; receiving money from members of the group; and funding at least one of purchase, operation, or maintenance of ecological alteration equipment at least partially through the money collected from the group, wherein the ecological alteration equipment includes wave driven water property alteration equipment.
- 35.** The method of claim **34**, further comprising: selling an interest in the group to at least one of at least one business, at least one government entity, at least one individual, or at least one insurance company.
- 36-38.** (canceled)
- 39.** The method of claim **34**, further comprising: creating different risk or reward zones based on known placement of the ecological alteration equipment.
- 40.** The method of claim **34**, further comprising: creating different risk or reward zones based on known placement of the ecological alteration equipment; and developing different payment amounts based on location relative to the risk or reward zones.
- 41.** The method of claim **34**, further comprising: developing different payment amounts based on potential property risk or reward.
- 42.** The method of claim **34**, further comprising: developing different payment amounts based on location.
- 43.** The method of claim **34**, wherein the ecological alteration equipment is designed to suppress tropical storms.
- 44.** The method of claim **34**, wherein the ecological alteration equipment is designed to suppress hurricanes.
- 45-48.** (canceled)
- 49.** The method of claim **34**, wherein the ecological alteration equipment comprises storm course alteration equipment.
- 50.** The method of claim **34**, wherein the ecological alteration equipment comprises biological alteration equipment.
- 51.** The method of claim **34**, wherein the ecological alteration equipment comprises biological augmentation equipment.
- 52.** A method of managing ecological alteration, comprising: operating ecological alteration equipment, the ecological alteration equipment including wave driven water property alteration equipment; receiving at least one payment from at least one interested party; receiving a request from the interested party to provide ecological alteration; and causing changes in the operation of ecological alteration equipment in an attempt to cause ecological alteration.
- 53.** The method of claim **52**, wherein the changes in the operation include causing movement of the ecological alteration equipment.
- 54.** The method of claim **52**, further comprising: selling ecological alteration services to at least one of at least one business, at least one insurance company at least one governmental entity, or at least one individual.
- 55-57.** (canceled)
- 58.** The method of claim **52**, further comprising: creating different risk or reward zones; and developing different payment amounts based on location relative to the zones.
- 59.** The method of claim **52**, further comprising: creating different risk or reward zones based on known placement of equipment; and developing different payment amounts based on location relative to the zones.
- 60.** The method of claim **52**, further comprising: creating risk or reward zones based on geographical location; and developing different payment amounts based on location relative to the zones.

- 61. The method of claim 52, wherein the ecological alteration includes at least one storm to be altered.
- 62. The method of claim 52, wherein the ecological alteration includes at least one hurricane to be altered.
- 63-66. (canceled)
- 67. The method of claim 52, wherein the ecological alteration equipment comprises storm course alteration equipment.
- 68. The method of claim 52, wherein the ecological alteration equipment comprises biological alteration equipment.
- 69. The method of claim 52, wherein the ecological alteration equipment comprises biological augmentation equipment.
- 70. A method of managing risk, comprising:
 operating storm suppression equipment in response to a request to attempt to alter at least one storm, the storm suppression equipment including wave driven water temperature alteration equipment;
 alerting at least one interested party as to the potential for storm damage;
 providing information to the at least one interested party of the cost and likelihood of reducing damage for the at least one interested party;
 receiving at least one payment from the at least one interested party; and
 receiving a request from the interested party to provide storm protection.
- 71. The method of claim 61, further comprising:
 selling storm protection services to at least one of at least one business, at least one government entity, at least one individual, or at least one insurance company.
- 72. (canceled)

- 73. (canceled)
- 74. The method of claim 61, further comprising:
 selling storm protection services to at least one oil company.
- 75. (canceled)
- 76. The method of claim 61, further comprising:
 creating different risk zones; and
 developing different payment amounts based on location relative to the zones.
- 77. The method of claim 61, further comprising:
 creating different risk zones based on geographical location; and
 developing different payment amounts based on location relative to the zones.
- 78. The method of claim 61, further comprising:
 creating different risk zones based on known placement of equipment; and
 developing different premiums based on location relative to the zones.
- 79. The method of claim 61, wherein the storm to be suppressed includes tropical storms.
- 80. The method of claim 61, wherein the storm to be suppressed includes hurricanes.
- 81-84. (canceled)
- 85. The method of claim 61, further comprising:
 developing a movement plan for the storm suppression equipment.
- 86. The method of claim 61, further comprising:
 developing a control plan for the storm suppression equipment.
- 87-111. (canceled)

* * * * *